

GATE FITTINGS

BRACKETS - GALVANIZED

Collar Style Bracket for Rollers	P. 44
Pipe Track Clamp-On Brackets for Rollers	P. 44
Safety Pipe Track Brackets	P. 44
2-Bolt Universal Holding Brackets	P. 45
Gate Holdback Brackets	P. 45

DROP ROD LATCH ASSEMBLIES

Double Drive Assembly - Residential	P. 41
Drop Rod Guide & Latch Assembly - Industrial	P. 41
Drop Rod Guides	P. 42
Drop Rods - With Hold Up Pinch Outs	P. 42
Industrial Latch Assembly Parts	
Guides	P. 43
Hold-Up Pins	P. 43
Yokes	P. 43

GATE FRAME HARDWARE

Truss Rods - Galvanized	P. 25
Truss Tighteners	P. 26
Turnbuckles	P. 26
Gate Rods	P. 27
Gate Corners	P. 28
Gate Clips	P. 29
Scrolls	P. 29

GATE FITTINGS

GATE STOPS

Slotted Center Stop - Malleable - Industrial Type P. 45

HINGES - GALVANIZED

Heavy Gate Hinges P. 30

Self-Closing Gate Hinge Assembly P. 30

Heavy Post Hinges P. 31

Heavy Angle Post Hinges P. 32

Hinge Bolts With Nuts P. 32

Industrial 180 Degree Hinge Assembly P. 33

Bulldog Industrial Hinge Assembly P. 34

Flat Wall 180 Degree Hinges P. 34

180 Degree Hinge Adaptors - Malleable P. 35

Socket Hinge Assembly - Mall. & Pressed Steel P. 35

Socket Hinge Plugs - Malleable P. 35

LATCHES - GALVANIZED

Clamp-On Fork Latches - Malleable P. 36

Clamp-On Fork Latches - Mall. & Pressed Steel P. 37

Rolling Gate Latches P. 37

Lock'n Latches P. 38

Spring Latch P. 38

Spring Latch Catches P. 39

Clamp-On Fork Latches - Self-Lifting P. 39

Fork Latches - Heavy Ribbed - Pressed Steel P. 40

Clamp-On Fork Latches - Butterfly Style P. 40

GATE FITTINGS

ROLLERS

Pipe Track Rollers - 5" & 5-1/2"

Everlast™ - Malleable P. 46

Duralast™ - Pressed Steel P. 46, 47

Pipe Track Rollers - 7"

Pressed Steel P. 47

Sand Cast Aluminum P. 47, 48

Cantilever Assemblies

Malleable P. 48

Nylon P. 48

Channel Rollers P. 48

Senior H Rollers P. 49

V Groove Rollers P. 49

ROLLING GATE ASSEMBLIES

EVERLAST™ Single Wheel Carrier

2" Rubber - Weld On P. 50

2" Rubber - Safety Guard Triangle Style P. 50

V Groove - Malleable P. 51

V Groove - Malleable Safety Guard Triangle Style P. 51

Frame Only - Weld On Style P. 52

EVERLAST™ Swing Gate Carrier P. 52

EVERLAST™ Double Wheel Carriers

2" Rubber - Residential - Clamp On P. 53

One Malleable V Groove - One 2" Rubber Wheel P. 53

2" Rubber - Heavy Duty P. 53

Industrial - Adjustable P. 54

Super Heavy P. 54

WHEELS

EVERLAST™ Rubber Wheels P. 54

TRUSS RODS - GALVANIZED

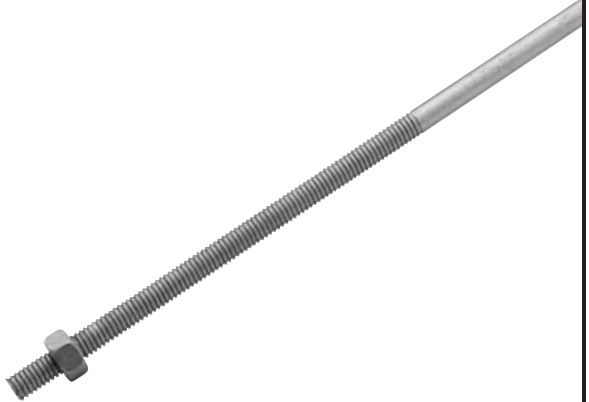
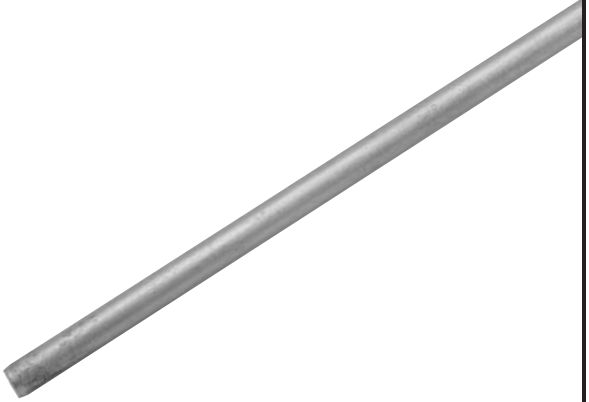
Part No.	Size	Per Bundle	Lbs Each	Threaded - With Nut
32122	3/8" x 8'	25	2.574	
32123	3/8" x 10'6"	25	3.379	
32124	3/8" x 12'	25	3.861	
32133	3/8" x 14'	25	4.505	
32136	3/8" x 20'	10	6.436	
Part No.	Size	Per Bundle	Lbs Each	For Trussing - Not Threaded
09960	5/16" x 20'	25	4.973	
09961	3/8" x 20'	25	6.436	
09962	1/2" x 20'	25	13.364	
09950	1/2" x 8'	25	5.346	
2 oz. zinc coating is available for all truss rods with advance notice				

TRUSS TIGHTENERS - GALVANIZED

Truss Tighteners Galvanized Pressed Steel		Part No.	Size	Per Bundle	Lbs Each
		32141	Heavy Industrial 3/8" x 1" x 5-1/2"	100	0.681
		<hr/>			
		32141-SI	Residential 1/4"x1"x4-1/2"	100	0.350
		<hr/>			
Turnbuckles Galvanized Malleable Body		Part No.	Size	Per Bundle	Lbs Each
		32151	4" - 3/8" EYE	100	0.400
		<hr/>			

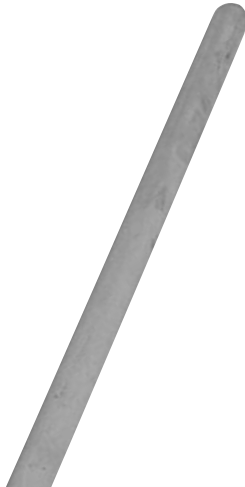
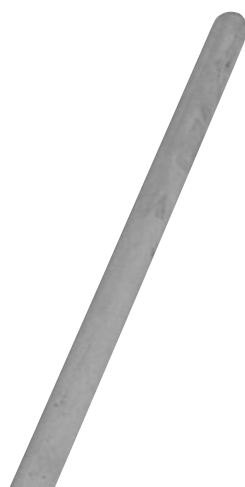
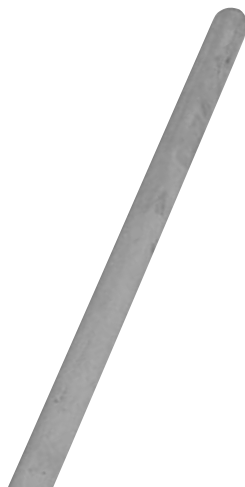

GATE RODS - GALVANIZED

Part No.	Size	Per Bundle	Lbs Each	Square Gates - 5/16" Round
09901	3' (31.5")	25	0.653	
09902	3.5' (37.5")	25	0.777	
09903	4' (43.5")	25	0.943	
09904	5' (55.5")	25	1.150	
09905	6' (67.5")	25	1.399	
Part No.	Size	Per Bundle	Lbs Each	Formed Gates - 5/16" Round
09921	3' (29")	25	0.601	
09922	3.5' (35")	25	0.725	
09923	4' (41")	25	0.850	
09924	5' (53")	25	1.098	
09925	6' (65")	25	1.347	
Part No.	Size	Per Bundle	Lbs Each	Extra Long - 5/16" Round
09927	4' (48")	25	0.995	
09929	5' (60")	25	1.243	
09931	6' (68")	25	1.409	
09939	6' (70")	25	1.450	
09940	6' (72")	25	1.492	
09947	6-1/2' (77")	25	1.596	

GATE CORNERS

Die Cast Aluminum Hex Style	Part No.	Size	Per Sack	Lbs Each
	20101	1-3/8"	100	0.350
	Part No.	Size	Per Sack	Lbs Each
Heavy - Industrial Pressed Steel	20103	1-5/8"	25	1.257
	20104	1-7/8"	25	1.532
	Part No.	Size	Per Sack	Lbs Each

GATE CLIPS - GALVANIZED

Part No.	Size	Per Sack	Lbs Each	Gate Fabric Clips 1/2" Wide x 1/8" GA.
15102	1-1/16"	500	0.090	
15103	1-5/16"	500	0.099	
15104	1-5/8"	500	0.132	
Part No.	Size	Per Sack	Lbs Each	Gate Fabric Clips - C Type Heavy 1/2" Wide x 1/8" GA.
15105	1-3/8"	500	0.132	

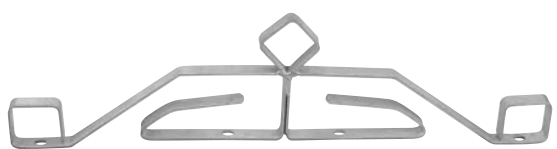

SCROLLS

Part No.	Size	Per Sack	Lbs Each	Heavy Galvanized Steel Three Piece - 12 GA. x 3/4"
29121	18"	10	1.300	
29122	24"	10	1.450	
29123	36"	10	1.750	
29124	48"	10	2.000	
Part No.	Size	Per Sack	Lbs Each	Heavy Galvanized Steel Square - 12 GA. x 3/4"
29141	18"	10	1.600	
29142	24"	10	1.950	
29143	36"	10	2.600	
29144	48"	10	3.100	

GATE HINGES - GALVANIZED

3/16" GA. Steel - 1/2" Socket		Part No.	Size	Per Sack	Lbs Each
	21101	1-1/16" x 1" Wide	100	0.369	
	21102	1-5/16" x 1" Wide	100	0.413	
	21103	1-5/8" x 1-1/4" Wide	100	0.621	
	21124	1-7/8" x 1-1/4" Wide	50	0.670	
	21126	2-3/8" x 1-1/4" Wide	50	0.761	
	21127	2-7/8" x 1-1/4" Wide	50	0.844	
3/16" GA. Steel - 5/8" Socket		Part No.	Size	Per Sack	Lbs Each
	21111	1-1/16" x 1" Wide	100	0.369	
	21112	1-5/16" x 1" Wide	100	0.413	
	21162	1-5/16" x 1-1/4" Wide	100	0.463	
	21163	1-5/8" x 1-1/4" Wide	100	0.621	
	21164	1-7/8" x 1-1/4" Wide	50	0.652	
	21166	2-3/8" x 1-1/4" Wide	50	0.770	
21167	2-7/8" x 1-1/2" Wide	50	0.980		
Self-Closing Gate Hinge Assembly		Part No.	Size	Per Sack	Lbs Each
<p>(Assembly Includes Post Hinge, Gate Hinge, Pivot Plate & Pivot Fork)</p> 	21185	1-5/16" x 1-7/8"	10	3.100	
	21186	1-5/16" x 2-3/8"	10	3.225	
	21187	1-5/16" x 2-7/8"	10	3.236	
	21191	1-5/8" x 1-7/8"	10	3.215	
	21192	1-5/8" x 2-3/8"	10	3.376	
	21193	1-5/8" x 2-7/8"	10	3.620	
	21195	1-7/8" x 1-7/8"	10	3.315	
	21196	1-7/8" x 2-3/8"	10	3.475	
	21197	1-7/8" x 2-7/8"	10	3.730	

POST HINGES - GALVANIZED

Part No.	Size	Per Sack	Lbs Each	Flat Wall - 5/8" Pin
21205	Pin Is Located 1" From Wall Plate	100	0.470	
Part No.	Size	Per Sack	Lbs Each	Heavy Industrial Type 1/2" Pin - 3/16" GA. Steel
21221	1-1/16" x 1" Wide	100	0.500	
21222	1-5/16" x 1" Wide	100	0.530	
21243	1-5/8" x 1-1/4" Wide	50	0.690	
21244	1-7/8" x 1-1/4" Wide	50	0.750	
21246	2-3/8" x 1-1/4" Wide	50	0.840	
21247	2-7/8" x 1-1/4" Wide	50	0.910	
Part No.	Size	Per Sack	Lbs Each	Heavy Industrial Type 5/8" Pin - 3/16" GA. Steel
21261	1-1/16" x 1" Wide	100	0.560	
21262	1-5/16" x 1" Wide	100	0.600	
21283	1-5/8" x 1-1/4" Wide	50	0.800	
21284	1-7/8" x 1-1/2" Wide	50	0.940	
21286	2-3/8" x 1-1/2" Wide	50	1.213	
21287	2-7/8" x 1-1/2" Wide	50	1.280	

POST HINGES - GALVANIZED

Heavy Industrial Type For Angle Post 3/16" GA. Steel x 1-1/4" Wide	Part No.	Size	Per Sack	Lbs Each
	21255	1/2" PIN	50	0.900
	21263	5/8" PIN	50	0.950
Back For Angle Post Hinge 3/16" - Pressed Steel	Part No.	Size	Per Sack	Lbs Each
	14135	1-1/4" Wide	50	0.320
	Hinge Bolts With Nuts	Part No.	Size	Per Sack
	11340	1/2" x 4-1/2"	125	0.353
	11341	1/2" x 6"	125	0.430
	11342	5/8" x 4-1/2"	125	0.584
	11343	5/8" x 6"	100	0.705
	11344	5/8" x 8"	50	0.849
	11345	5/8" x 10"	50	0.926
	11346	5/8" x 12"	50	1.146



HINGES - GALVANIZED

Industrial 180 Degree Hinge Assembly

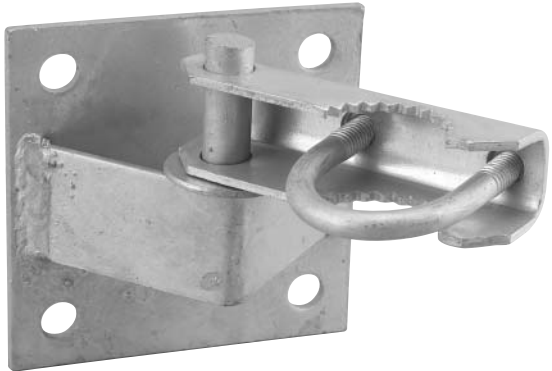

(Assembly Includes 1 Gate Bracket,
1 Post Bracket & 2 U-Bolts w/ Nuts)

Part No.	Size	Per Sack	Lbs Each	Gate Frame Size - 1-5/8" & 1-7/8"
21326	2-3/8"	10	3.450	
21327	2-7/8"	10	3.520	
21329	3-1/2"	10	3.980	
21330	4"	10	4.010	
21331	4-1/2"	10	4.540	
21333	6-5/8"	6	6.690	
21334	8-5/8"	6	9.400	
Part No.	Size	Per Sack	Lbs Each	Gate Frame Size - 2-3/8"
21305	2-3/8"	10	3.600	
21306	2-7/8"	10	3.620	
21307	3-1/2"	10	3.980	
21308	4"	10	4.160	
21309	4-1/2"	10	4.540	
21310	6-5/8"	6	6.690	
21311	8-5/8"	6	9.400	
Part No.	Size	Per Sack	Lbs Each	Gate Frame Size - 2-7/8"
21315	2-7/8"	10	3.620	
21316	3-1/2"	10	3.980	
21317	4"	10	4.160	
21318	4-1/2"	10	4.540	
21319	6-5/8"	6	6.690	
21320	8-5/8"	6	9.400	



HINGES - GALVANIZED

Flat Wall - 180 Degree	Part No.	Size	Per Sack	Lbs Each
	21341	1-5/8" ~1-7/8"	10	3.970
	21312	2-3/8"	10	3.970
	21321	2-7/8"	10	3.970
Bulldog Industrial Hinge Assembly - Pressed Steel Fits 1-5/8" or 1-7/8" Gates	Part No.	Size	Per Sack	Lbs Each
<p data-bbox="186 1144 625 1239">(Assembly Includes One Each: Post Bracket, Gate Bracket, U-Bolt and Carriage Bolt)</p> 	21407	2-7/8"	10	3.680
	21409	3-1/2"	10	4.300
	21410	4"	10	4.330
	21411	4-1/2"	10	4.390
	21413	6-5/8"	4	7.130

HINGES - GALVANIZED

Part No.	Size	Per Sack	Lbs Each	Socket Hinge Assembly Malleable & Pressed Steel Fits 1-5/8" or 1-7/8" Gates
21366	2-3/8"	12	3.935	
21367	2-7/8"	12	4.840	
21369	3-1/2"	12	4.940	
21370	4"	12	4.872	
21373	6-5/8"	4	12.015	
21374	8-5/8"	4	16.248	
Part No.	Size	Per Sack	Lbs Each	180 Degree Hinge Adaptors Malleable
21381	1-7/8" x 1-7/8"	10	4.290	
Part No.	Size	Per Sack	Lbs Each	Socket Hinge Plugs - Malleable
25211	1-5/8"	24	1.300	
25212	1-7/8"	24	1.410	

LATCHES - GALVANIZED

Malleable Steel Clamp-On Fork Latch Assembly With Bent Bolt	Part No.	Size	Per Sack	Lbs Each
	23302	1-5/16" x 1-3/8"	25	1.330
	23304	1-5/16" x 1-7/8"	25	1.390
	23306	1-5/16" x 2-3/8"	25	1.430
	23307	1-5/16" x 2-7/8"	25	1.480
	23309	1-5/16" x 3-1/2"	10	1.610
	23310	1-5/16" x 4"	10	1.770
	23311	1-5/16" x 4-1/2"	10	1.770
	23322	1-5/8" x 1-3/8"	25	1.390
	23324	1-5/8" x 1-7/8"	25	1.470
	23326	1-5/8" x 2-3/8"	25	1.500
	23327	1-5/8" x 2-7/8"	25	1.560
	23329	1-5/8" x 3-1/2"	10	1.638
	23330	1-5/8" x 4"	10	1.840
	23331	1-5/8" x 4-1/2"	10	1.840
	23342	1-7/8" x 1-3/8"	25	1.600
	23344	1-7/8" x 1-7/8"	25	1.670
	23346	1-7/8" x 2-3/8"	25	1.700
	23347	1-7/8" x 2-7/8"	25	1.750
	23349	1-7/8" x 3-1/2"	10	1.860
	23350	1-7/8" x 4"	10	2.040
23351	1-7/8" x 4-1/2"	10	2.040	
Malleable Steel Heavy Duty Fork Latches For Maximum Security Facilities	Part No.	Size	Per Sack	Lbs Each
 <p data-bbox="147 1730 358 1787">2-3/8" for Maximum Security</p>	23375	2-3/8" x 1-3/8"	25	1.810
	23376	2-3/8" x 1-7/8"	25	1.880
	23377	2-3/8" x 2-3/8"	25	1.910
	23378	2-3/8" x 2-7/8"	25	1.960
	23379	2-3/8" x 3-1/2"	10	2.090
	23352	2-3/8" x 4"	10	2.250
	23353	2-3/8" x 4-1/2"	10	2.250

LATCHES - GALVANIZED

Part No.	Size	Per Sack	Lbs Each	Malleable & Pressed Steel Clamp-On Fork Latch Assembly With Bent Bolt
23359	1-5/8" x 5-9/16"	10	2.830	
23360	1-7/8" x 5-9/16"	10	3.030	
23361	2-3/8" x 5-9/16"	10	3.100	
23355	1-5/8" x 6-5/8"	10	2.950	
23356	1-7/8" x 6-5/8"	10	3.100	
23357	2-3/8" x 6-5/8"	10	3.220	
23363	1-5/8" x 8-5/8"	10	4.110	
23364	1-7/8" x 8-5/8"	10	4.270	
23365	2-3/8" x 8-5/8"	10	4.380	
Part No.	Size	Per Sack	Lbs Each	Pressed Steel Bent Bolts w/ Nut For Malleable Clamp-On Fork Latches
11441	1-5/16"	50	0.130	
11442	1-5/8"	50	0.140	
11443	1-7/8"	50	0.150	
11444	2-3/8"	50	0.180	
Part No.	Size	Per Sack	Lbs Each	Pressed Steel Rolling Gate Latches
23461	1-5/8" OR 1-7/8"	10	2.310	
23462	1-5/8"	10	2.310	
23463	1-7/8"	10	2.310	

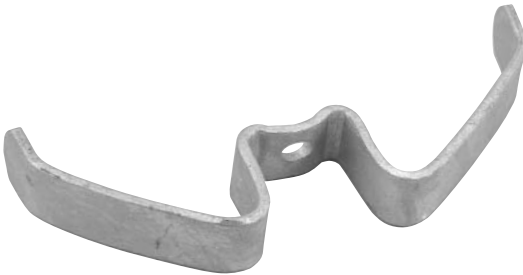

LATCHES - GALVANIZED

Spring Latch	Part No.	Size	Per Sack	Lbs Each
	23445	1-3/8"	25	0.72
Spring Latch Catch	Part No.	Size	Per Sack	Lbs Each
	23451	Universal-Fits All	250	0.240
Spring Latch Catch For Flat Surface	Part No.	Size	Per Sack	Lbs Each
	23455	Universal-Fits All	500	0.150

LATCHES - GALVANIZED

Part No.	Size	Per Sack	Lbs Each	Pressed Steel Lock'n Latch
	Regular			
23459	1-5/8" OR 1-7/8"	10	1.5	
	Offset			
23460	1-5/8" OR 1-7/8"	10	1.5	
Part No.	Size	Per Sack	Lbs Each	Pressed Steel Clamp-On Fork Type Self-Lifting - Self-Latching (Bent Bolts Included)
23173	1-5/16" x 1-3/8"	50	1.650	
23174	1-5/16" x 1-7/8"	50	1.760	
23176	1-5/16" x 2-3/8"	50	1.860	

LATCHES - GALVANIZED

Pressed Steel Bolt On - Band Type Little Ear Butterfly Self-Lifting - Self-Latching	Part No.	Size	Per Sack	Lbs Each
	23202	1-5/16" x 1-3/8"	25	1.770
	23204	1-5/16" x 1-7/8"	25	1.840
	23206	1-5/16" x 2-3/8"	25	1.890
	23207	1-5/16" x 2-7/8"	25	1.940
	23216	1-5/16" x Angle Post	25	1.830
	23222	1-5/8" x 1-3/8"	25	1.700
	23224	1-5/8" x 1-7/8"	25	1.800
	23226	1-5/8" x 2-3/8"	25	1.850
	23227	1-5/8" x 2-7/8"	25	1.900
	23236	1-5/8" x Angle Post	25	1.800
	23238	1-7/8" x 1-3/8"	25	1.680
	23239	1-7/8" x 1-7/8"	25	1.780
	23240	1-7/8" x 2-3/8"	25	1.830
23241	1-7/8" x 2-7/8"	25	1.880	
Pressed Steel Big Ear Butterfly Self-Latching	Part No.	Size	Per Sack	Lbs Each
(Bent Bolts Included) 	23242	1-5/16" x 1-7/8"	25	1.800
	23263	1-5/16" x 2-3/8"	25	1.900
Pressed Steel Fork Latches Heavy Ribbed	Part No.	Size	Per Sack	Lbs Each
	23102	1-3/8" x 1-3/8"	25	0.800
	23104	1-3/8" x 1-7/8"	25	0.960
	23105	1-5/16" x 2-7/8"	25	1.150
	23106	1-5/16" x 2-3/8"	25	1.060
	23107	1-5/8" x 2-7/8"	25	1.250
	23108	1-5/8" x 4"	25	1.400
	23114	1-5/8" x 1-7/8"	25	1.070
	23116	1-5/8" x 2-3/8"	25	1.100
	23117	1-7/8" x 4"	25	1.420
	23118	1-7/8" x 2-3/8"	25	1.080
23119	1-7/8" x 2-7/8"	25	1.170	

DROP ROD LATCH ASSEMBLIES - GALVANIZED

Part No.	Size	Per Sack	Lbs Each
17161	1-5/8" - 3 Guides	15	5.150
17162	1-7/8" - 3 Guides	15	5.290
17163	1-5/8" - 2 Guides	20	4.030
17164	1-7/8" - 2 Guides	20	4.180
17165	2-3/8" - 3 Guides	15	5.250
17166	2-3/8" - 2 Guides	20	4.170

**Industrial
Guide & Latch Assembly**

(Assembly Includes 1 Fork + Guides w/ Bolts
and 5/16 x 2" Hold-Up Pin)



A photograph showing a close-up of the industrial guide and latch assembly. It features two vertical metal rods. A horizontal metal bracket with a handle is attached to the rods. A small lock mechanism is visible at the bottom of the assembly.

Part No.	Size	Per Sack	Lbs Each
17151	36"	25	3.250
17152	44"	25	3.710

**Residential Galvanized Steel
Double Drive Assembly
Clamps-On 1-5/16" O.D. Gate**

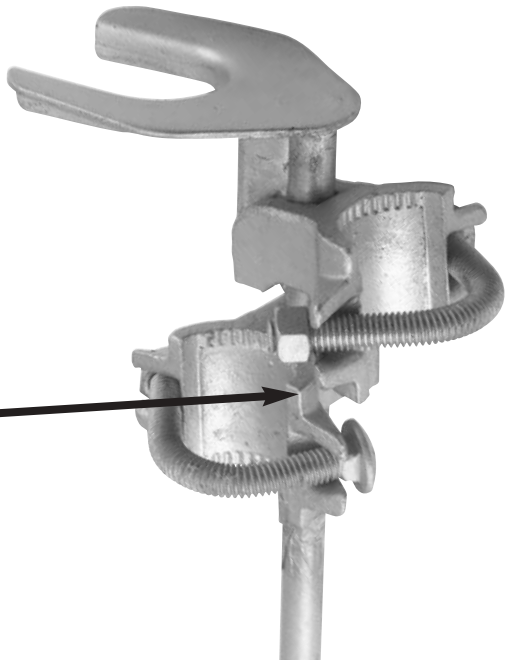

(Assembly Includes 2 Malleable Guides
and 1-5/16" Bent Bolts)





A photograph showing a close-up of the residential double drive assembly. It features a large, curved handle at the top. Below the handle is a complex metal assembly with a threaded rod and a nut. An arrow points from the text below to a specific part of the assembly.

Drop latch can be lifted to the top of the upper guides, so the bottom of the lock can be rotated around the top of the guide to allow one gate to open, while the other gate is still in place by the drop rod.

DROP ROD LATCH ASSEMBLY PARTS

Guide - Pressed Steel Residential 5/16" Gate Frame	Part No.	Size	Per Sack	Lbs Each
	17141	For 1/2" Rods	250	0.095
	<th data-bbox="716 791 891 840">Part No.</th> <th data-bbox="894 791 1164 840">Size</th> <th data-bbox="1167 791 1333 840">Per Sack</th> <th data-bbox="1336 791 1476 840">Lbs Each</th>	Part No.	Size	Per Sack
	80621	1-5/16"	50	0.420
	<th data-bbox="716 1365 891 1413">Part No.</th> <th data-bbox="894 1365 1164 1413">Size</th> <th data-bbox="1167 1365 1333 1413">Per Sack</th> <th data-bbox="1336 1365 1476 1413">Lbs Each</th>	Part No.	Size	Per Sack
	17101	12" x 1/2"	25	0.900
	17102	18" x 1/2"	25	1.240
	17103	24" x 1/2"	25	1.480
	17104	30" x 1/2"	25	1.800
	17105	36" x 1/2"	25	2.385
	17106	44" x 1/2"	25	2.870

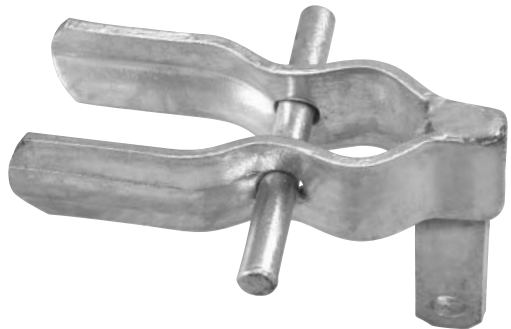

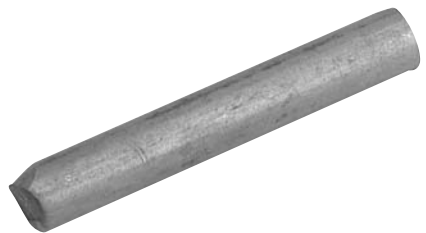
PARTS: INDUSTRIAL LATCH ASSEMBLY

Part No.	Size	Per Sack	Lbs Each	Yokes
17300	1-5/8"	25	1.764	
17301	1-7/8"	25	1.764	
17302	2-3/8"	25	1.820	
Part No.	Size	Per Sack	Lbs Each	Guides
17201	1-5/8"	50	1.000	
17202	1-7/8"	50	1.100	
17203	2-3/8"	50	1.200	
Part No.	Size	Per Sack	Lbs Each	Hold-Up Pins
80925	5/16 x 2"	50	0.050	

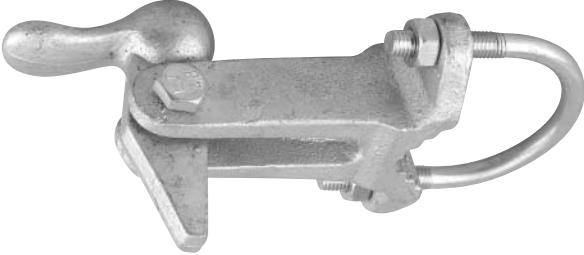

BRACKETS - GALVANIZED

Heavy Industrial Pipe Track Clamp-On Assembly For Rollers With 1/2" x 2" U-Bolt & Nuts	Part No.	Size	Per Sack	Lbs Each
	12161	1-5/8"~1-7/8" x 1/2"	25	1.640
	12162	1-5/8"~1-7/8" x 5/8"	25	1.640
Pressed Steel Clamp-On For Rollers Collar Style - Economy Type	Part No.	Size	Per Sack	Lbs Each
	12171	1-3/8" x 5/8"	25	0.400
	12172	1-5/8" x 5/8"	25	0.510
	12173	1-7/8" x 5/8"	25	0.680
Pressed Steel Safety Pipe Track Clamp-On Assembly With U-Bolt & Nuts	Part No.	Size	Per Sack	Lbs Each
	12141	1-5/8" OR 1-7/8"	25	2.400
	12142	2-3/8" OR 2-7/8"	25	2.450
	12143	3-1/2" OR 4"	25	3.360
Pressed Steel Safety Pipe Track Clamp-On	Part No.	Size	Per Sack	Lbs Each
	12144	FLAT SURFACE	25	2.560

BRACKETS - GALVANIZED

Part No.	Size	Per Sack	Lbs Each	EVERLAST™ 2-Bolt Universal Holding Assembly
12152	1-5/8" OR 1-7/8"	50	1.984	(Assembly Includes 2 U-Bolts with Nuts) 
Part No.	Size	Per Sack	Lbs Each	Gate Holdback Assembly Malleable
20122	1-5/8" OR 1-7/8"	20	2.910	(Assembly Includes U-Bolt with Nuts) 
Part No.	Size	Per Sack	Lbs Each	Slotted Center Stop Malleable - Industrial Type
17181	Mushroom Type	10	3.858	

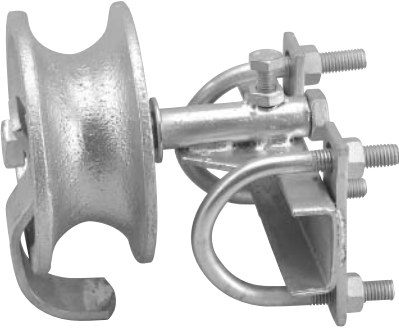
ROLLERS

EVERLAST™ 5" Pipe Track - Malleable With Outside Retainer	Part No.	Size	Per Sack	Lbs Each
	28104	5" x 1-5/8" OD	8	5.375
EVERLAST™ 5" Pipe Track - Malleable With Outside Retainer And 2 Bolt Universal Holding Bracket	Part No.	Size	Per Sack	Lbs Each
	28104-2	5" x 1-5/8" OD	4	8.595
DURALAST™ 5-1/2" Pipe Track - Pressed Steel With Outside Retainer	Part No.	Size	Per Sack	Lbs Each
	28108	5-1/2" x 1-5/8" OD	10	3.170

ROLLERS

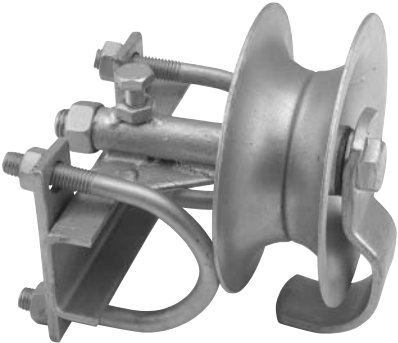
Part No.	Size	Per Sack	Lbs Each	
28112	5-1/2" x 1-5/8" OD	4	5.165	<p>DURALAST™ 5-1/2" Pipe Track - Pressed Steel With Outside Retainer And 2 Bolt Universal Holding Bracket</p> 
28123	7" x 1-5/8" OD	10	4.575	<p>7" Pipe Track - Pressed Steel With Outside Retainer</p> 
28131	7" x 1-5/8" OD	10	3.865	<p>7" Pipe Track Sand Cast Aluminum With Outside Retainer</p> 

ROLLERS

<p>7" - Sand Cast Aluminum With Retainer And 2 Bolt Everlast™ Holding Bracket</p>	<p>Part No.</p>	<p>Size</p>	<p>Per Sack</p>	<p>Lbs Each</p>
	<p>28133</p>	<p>7" x 1-5/8" OD</p>	<p>4</p>	<p>5.000</p>
<p>Cantilever Gate Roller Assembly With U-Bolts & Nuts - Malleable</p>	<p>Part No.</p>	<p>Size</p>	<p>Per Sack</p>	<p>Lbs Each</p>
	<p>28142</p>	<p>2-7/8" x 2-3/8" OD</p>	<p>4</p>	<p>14.000</p>
	<p>28143M</p>	<p>4" MEGA x 2-3/8"</p>	<p>2</p>	<p>27.500</p>
	<p>28152</p>	<p>6-5/8" x 2-3/8"</p>	<p>2</p>	<p>34.000</p>
<p>Nylon Cantilever Gate Roller With S. S. Shaft & Delrin Bushing Complete Assembly</p>	<p>Part No.</p>	<p>Size</p>	<p>Per Sack</p>	<p>Lbs Each</p>
	<p>28143-N</p>	<p>4" x 2-3/8"</p>	<p>2</p>	<p>11.000</p>

ROLLERS

Part No.	Size	Per Sack	Lbs Each	
28161	3-1/2" - CHANNEL	15	2.205	EVERLAST™ Roller & Axle Assembly For Gates - Malleable
				EVERLAST™ 5" Senior H Roller & Axle Assembly Malleable
28181	FOR SR H POST 2" TRACK	10	5.700	
				EVERLAST™ V Groove - Malleable With Delrin Bushing
28192	4" - ANGLE	4	4.300	
28190	6" - ANGLE	4	7.100	

ROLLING GATE ASSEMBLIES

EVERLAST™ 2" Wide Rubber Single Wheel Carrier Assembly Weld On Style	Part No.	Size	Per Sack	Lbs Each
	13101	1-3/8" x 6"	4	5.80
	13102	1-5/8" x 6"	4	5.85
	13103	1-7/8" x 6"	4	6.84
	13104	1-5/8" x 8"	4	8.64
	13105	1-7/8" x 8"	4	8.82
EVERLAST™ 2" Wide Rubber Single Wheel Carrier Assembly SAFETY GUARD - Triangle Style	Part No.	Size	Per Sack	Lbs Each
	13141	6"	6	6.83



ROLLING GATE ASSEMBLIES

Part No.	Size	Per Sack	Lbs Each	
13180	1-7/8" x 6"	4	10.00	<p>EVERLAST™ V Groove - Malleable Single Wheel Carrier Assembly Weld On Style</p> 
13161	6"	6	8.00	<p>EVERLAST™ V Groove - Malleable Single Wheel Carrier Assembly SAFETY GUARD - Triangle Style For Angle Track</p> 

ROLLING GATE ASSEMBLIES

One Piece Single Wheel Carrier Frame Only - Weld On Style	Part No.	Size	Per Sack	Lbs Each
	13111	1-5/16" x 6"	25	1.56
	13112	1-5/8" x 6"	25	1.56
	13113	1-7/8" x 6"	25	3.00
	13114	1-5/8" x 8"	25	3.20
	13115	1-7/8" x 8"	25	3.50
EVERLAST™ Swing Gate Carrier 2" Wide Rubber Wheel Assembly With U-Bolts & Nuts	Part No.	Size	Per Sack	Lbs Each
	13171	1-5/8" or 1-7/8" x 6"	6	6.80
	13172	1-5/8" or 1-7/8" x 8"	6	9.20

ROLLING GATE ASSEMBLIES

Part No.	Size	Per Sack	Lbs Each	
13151	1-5/8"~1-7/8" x 6"	4	10.30	EVERLAST™ Residential 2" Wide Rubber Double Wheel Carrier Assembly Clamp-On Style - 5/8" Hub Wheels Hub To Hub 15" Wide
13152	1-5/8"~1-7/8" x 8"	4	14.80	
				
Part No.	Size	Per Sack	Lbs Each	
13165	1-5/8"~1-7/8" x 6"	4	15.60	EVERLAST™ Double Wheel Carrier Assembly One 6" Malleable V Groove And One 2" x 6" Rubber Wheel Hub To Hub 18" Wide
				
Part No.	Size	Per Sack	Lbs Each	
13142	1-5/8"~1-7/8" x 6"	4	14.50	EVERLAST™ Heavy Duty 2" Wide Rubber Double Wheel Carrier Assembly Hub To Hub 19" Wide
13143	1-5/8"~1-7/8" x 8"	4	19.00	
				

ROLLING GATE ASSEMBLIES

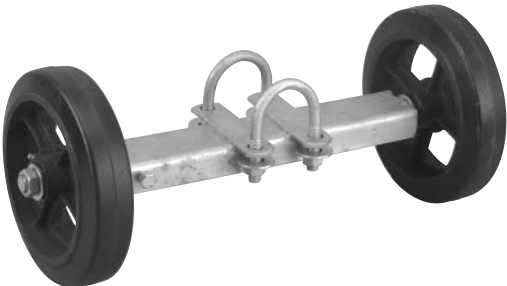
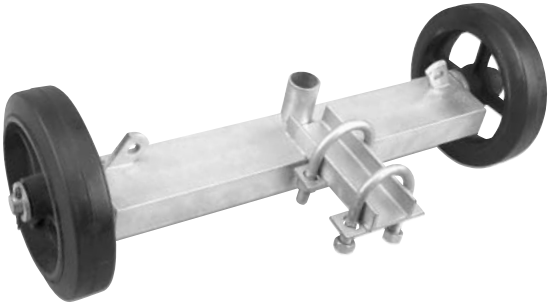
EVERLAST™ Double Wheel Carrier Industrial Adjustable Hub To Hub 19-1/2" Wide	Part No.	Size	Per Sack	Lbs Each
	13128	6"	4	13.50
	13130	8"	4	18.00
				
EVERSTRONG Double Wheel Carrier Super Heavy Hub To Hub 24" Wide	Part No.	Size	Per Sack	Lbs Each
	13149	1-5/8" x 1-7/8" x 8"	1	26.00
				
EVERLAST™ 2" Wide Replacement Rubber Wheels	Part No.	Size	Per Sack	Lbs Each
	34302	5/8" HUB x 6"	10	3.52
	34304	5/8" HUB x 8"	10	5.46
